

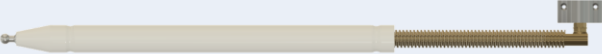







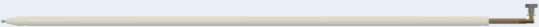

TM

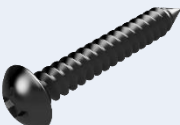
**STABLE
CAMPER**

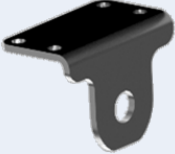

Parts List	# of Items	
Jack Clamp	2	
Front End Tube Assembly	2	
Front Storage Mount	1	
Truck Bed Side Tube Assembly	2	
#10 x 1.5" Stainless Steel Flat Head Screw	8	
#10 x 3/4" Stainless Steel Pan Head Screw	16	

Parts List	# of items	
Side Storage Hanger Mount Front	2	
Side Storage Hanger Mount Rear	2	
Allen Wrench	1	
*For Lance and Chalet Campers Only** Bracket Extension	2	

****Please note: Please read carefully the instructions on page 9. The 3M VHB tape on the front and rear side storage hanger mounts is very strong and repositioning the mounts after they have been fixed to the camper is not advised.**

General Notes:

- **Before you begin the installation, remove the camper from the truck and make sure it is leveled.**
- **All mounted assemblies will need to be securely attached with supplied hardware to the camper frame.**
- **Avoid drilling pilot holes too close to the edge of the camper frame.**
- **Check the front tubes and hanger mounts as well as the side tubes and hanger mounts for any possible clearance issues.**
- **Confirm that the tubes will not be interfering with the tie down hooks, water, or any connections under the camper overhang.**
- **Apply RV sealant to all holes.**
- **Wear proper safety equipment.**
- **Do not stand, sit or climb on stablecamper.**
- **The 3M VHB tape used on the front and rear side storage hanger mounts is very strong and repositioning the mounts after they have been fixed to the camper is not advised. When installing the mounts, be sure of placement before removing the adhesive backing and attaching the mounts with the supplied hardware.**

Mount the jack clamps to the fixed portion of the jack.

Drivers Side

Passenger Side

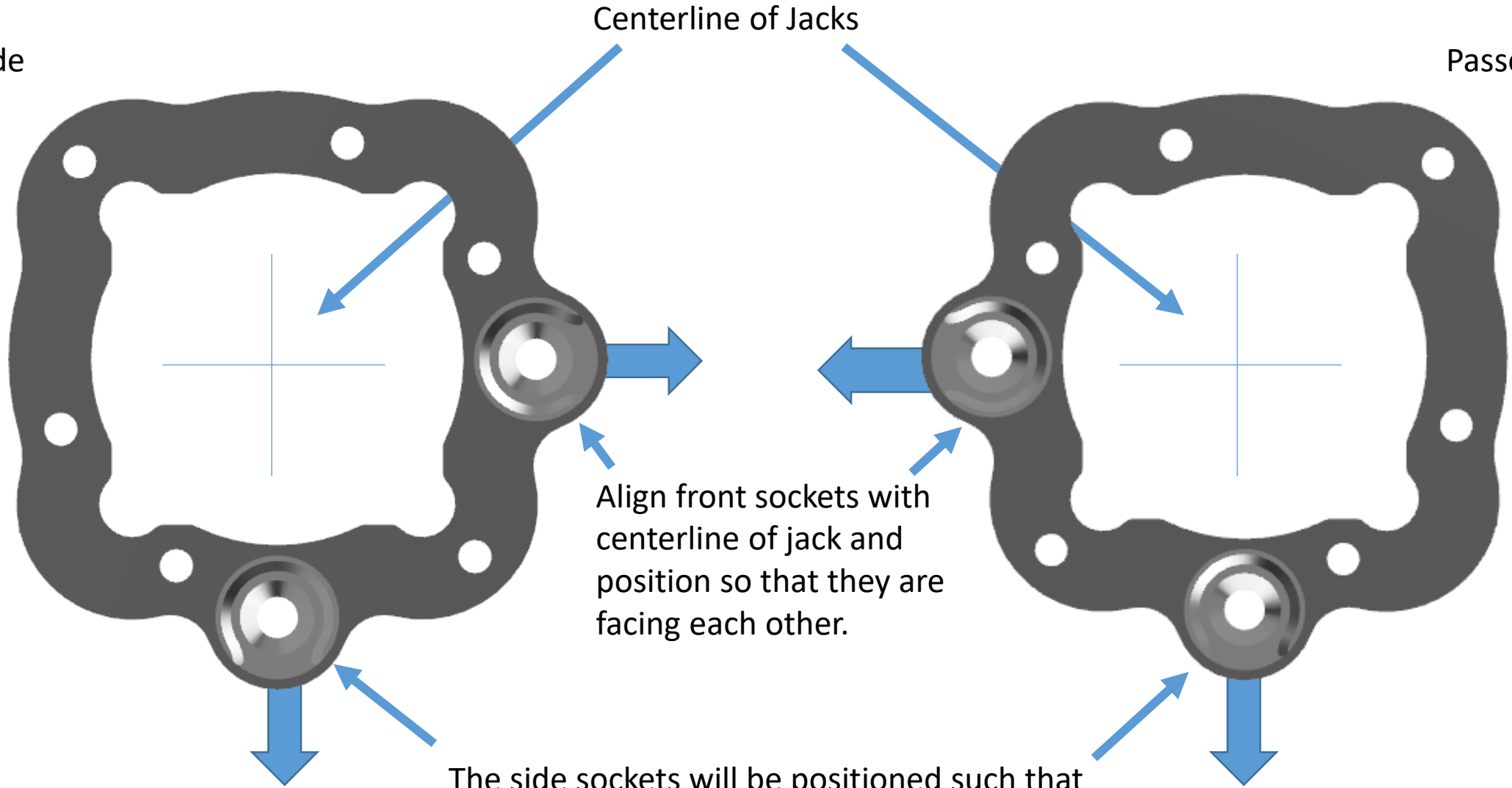

Align front sockets with centerline of jack and position so that they are facing each other.

The side sockets will be positioned such that they are collinear with the centerline of the jack as shown in the illustration.

Jack Clamp Assembly Exploded View



Vertical Placement of Jack Clamp

Vertical placement of jack clamp will vary depending on the maximum angle of the front tube.

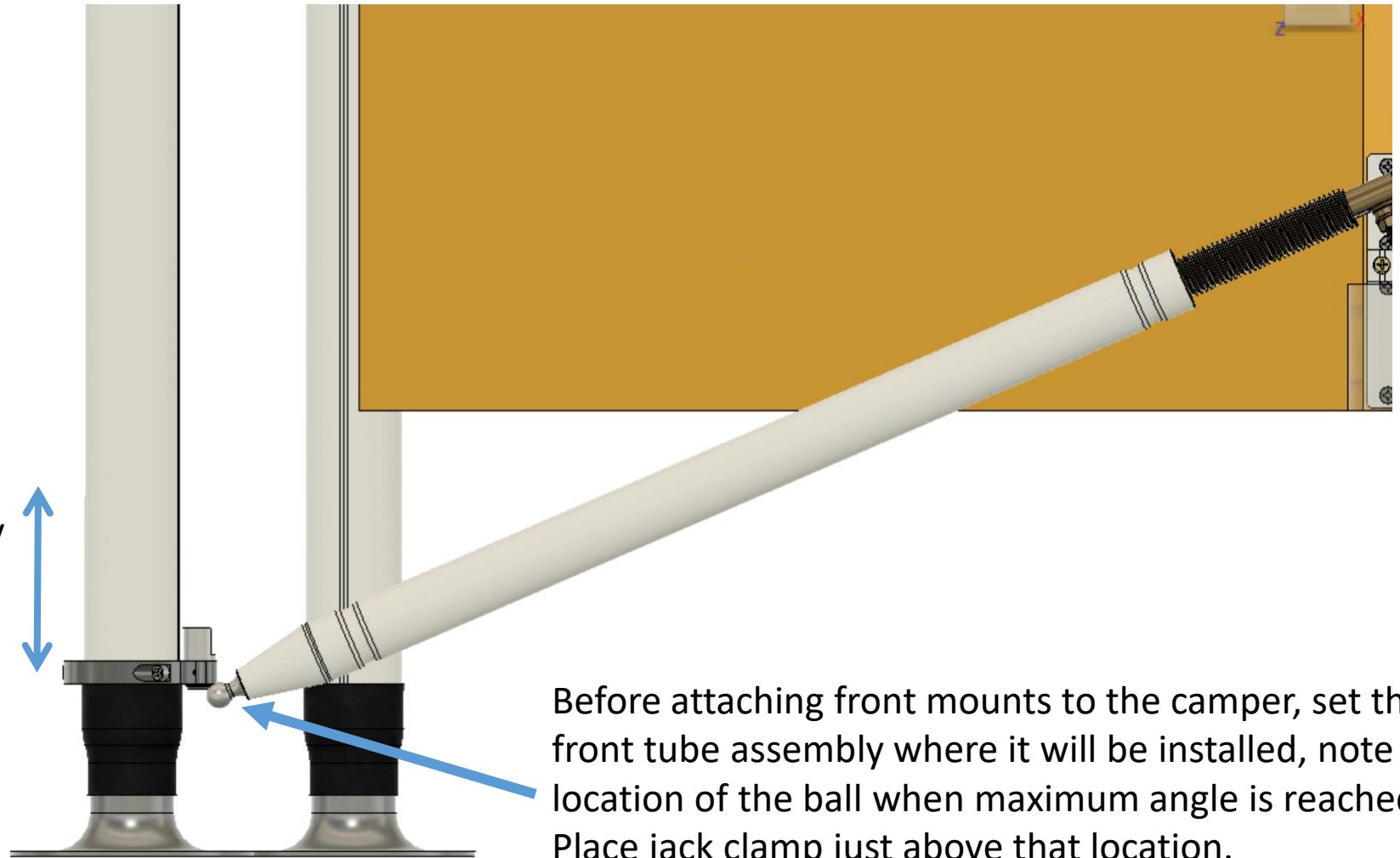

Before attaching front mounts to the camper, set the front tube assembly where it will be installed, note location of the ball when maximum angle is reached. Place jack clamp just above that location.

Passenger Side

Driver Side

View: Front Face of Camper

Install the front tube mounts. Position the tube mounts near the lower exterior corners of the camper, attaching to the camper frame. Drill (2) 9/64" pilot holes per mount and attach the mounts with the #10x1.5" flat head screws.

Do not drill pilot holes too close to the edge of the camper frame. Use RV sealant on any holes and around the mounts.

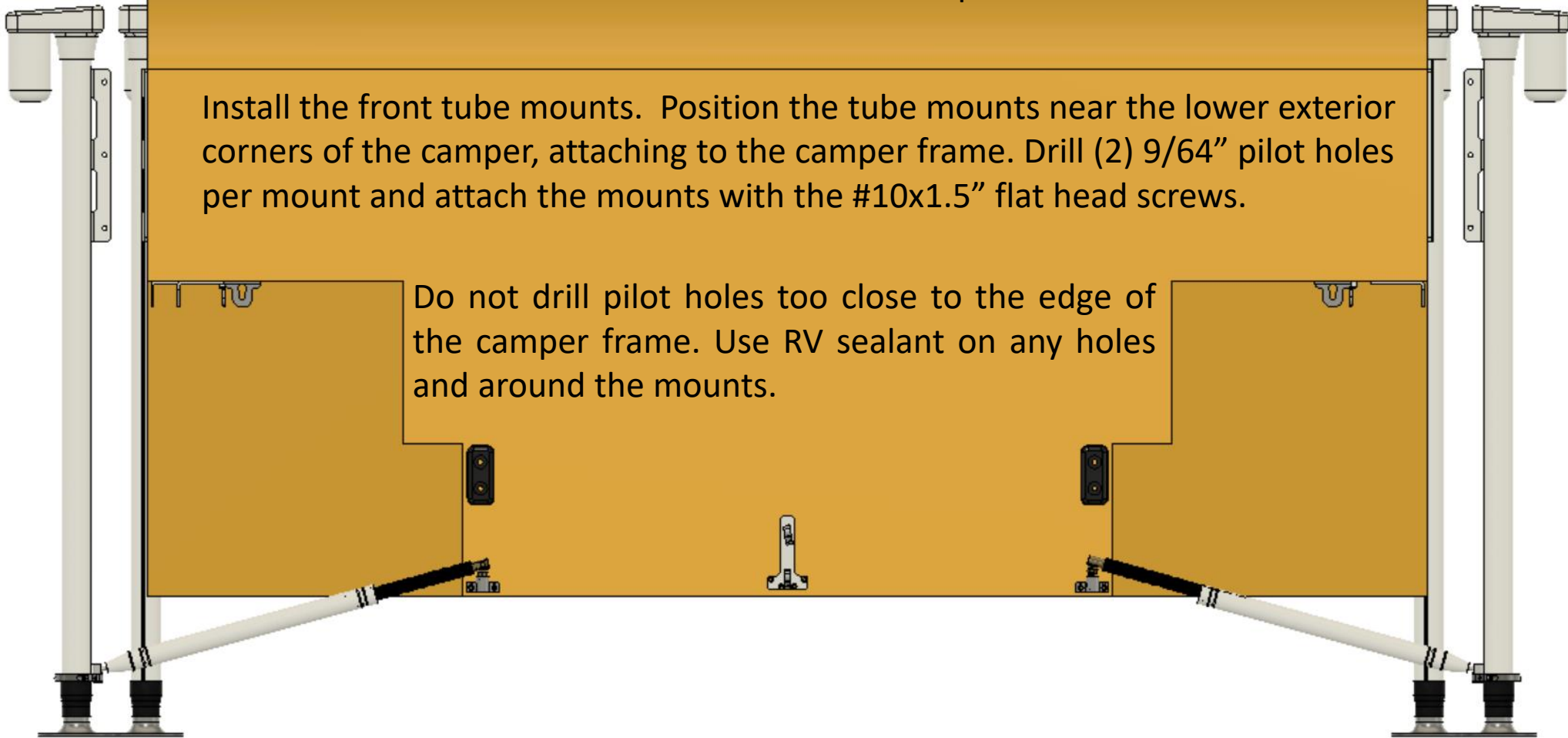

Passenger Side

Driver Side

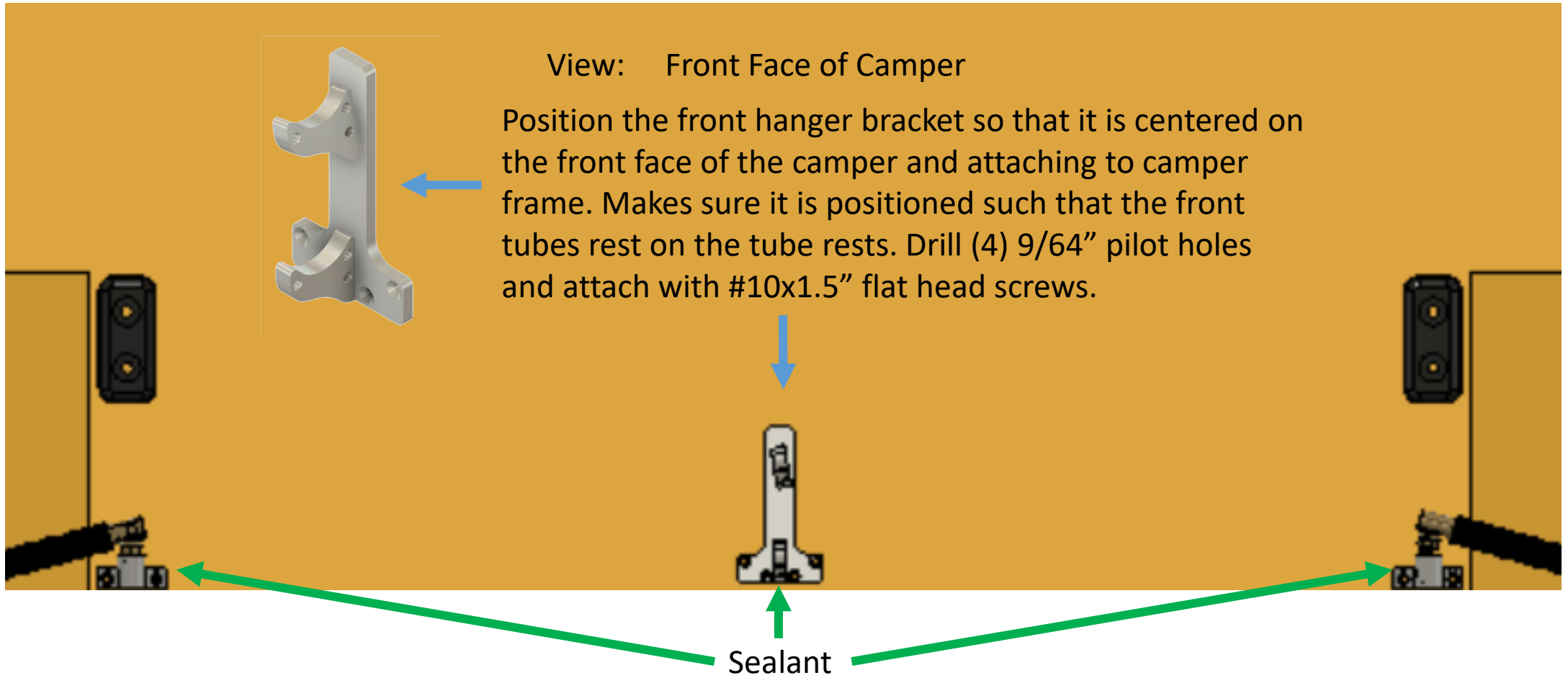

View: Side Face of Camper

- Before installing the storage mounts for the side tubes on the underside of the camper, confirm that the distance between the hanger mounts is the same as the installed length of the Stablecamper before drilling pilot holes.

Installed length of Stablecamper

****The 3M VHB tape used on the front and rear side storage hanger mounts is very strong and repositioning the mounts after they have been fixed to the camper is not advised. Be sure of placement before attaching to camper.**

Zoomed in view of Front Hanging Mount

- Once stored on the hanging mounts, the tubes hang 2" below the underside of the camper. The exact placement of the hanging mounts will depend on the truck and your specific clearance needs. The mounts can be placed on the inside or the outside of the truck bedrail depending on your rig and setup.

Side Storage Hanger Mount Rear Detail

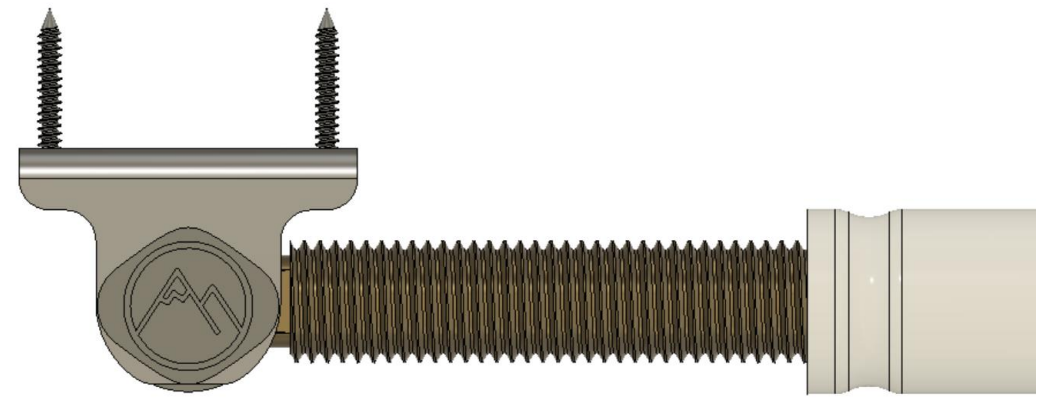
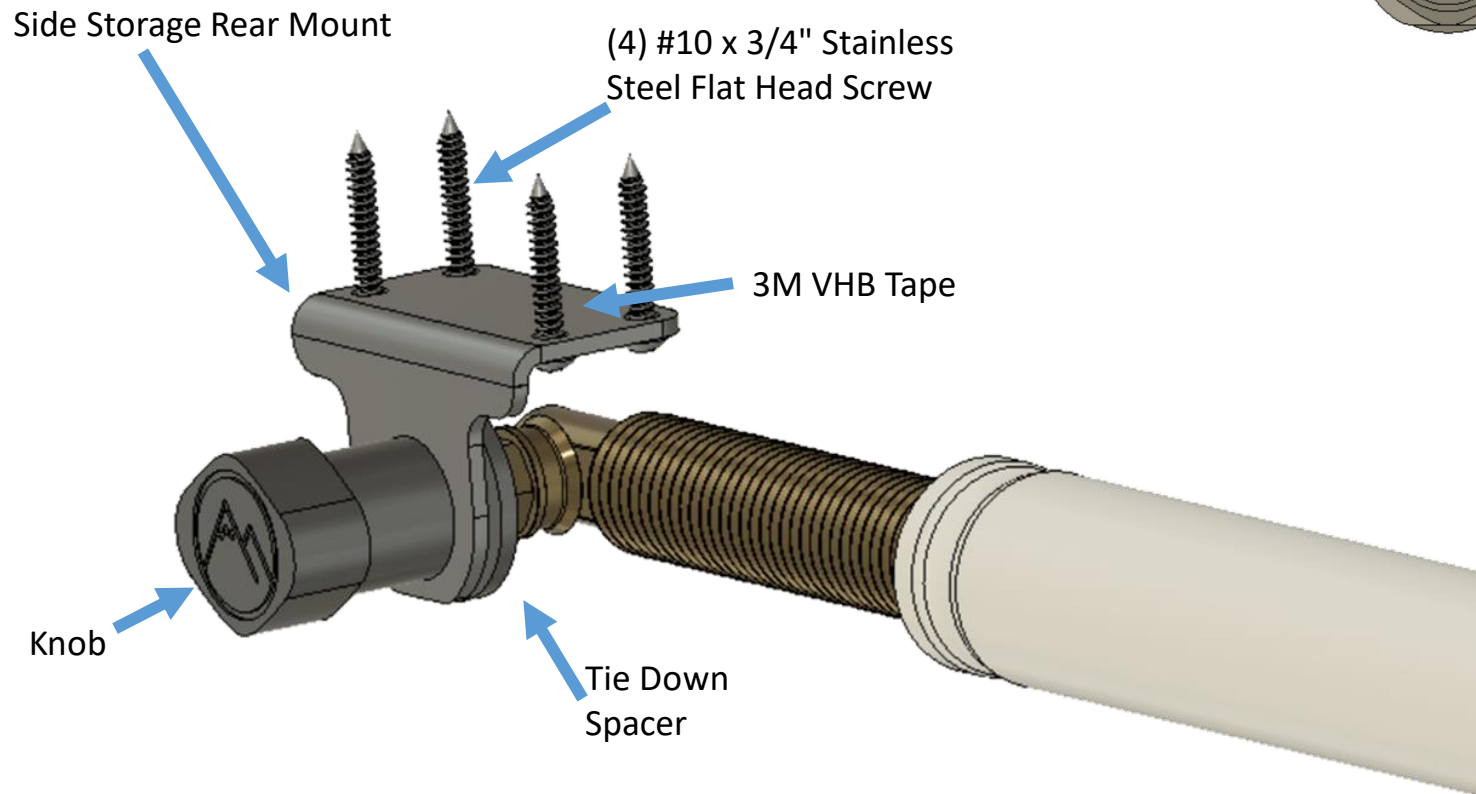

****Please note: The 3M VHB tape used on the front and rear side storage hanger mounts is very strong and repositioning the mounts after they have been fixed to the camper is not advised. When installing the mounts, be sure of placement before removing the adhesive backing and attaching the mounts with the screws.**

Side Storage Front Mount Detail

For side tube storage, insert the ball through the keyhole (resting against the neck of the ball). Attach the rear end of the tube to its rear hanger mount and rotate the tube to tension the tube as desired.

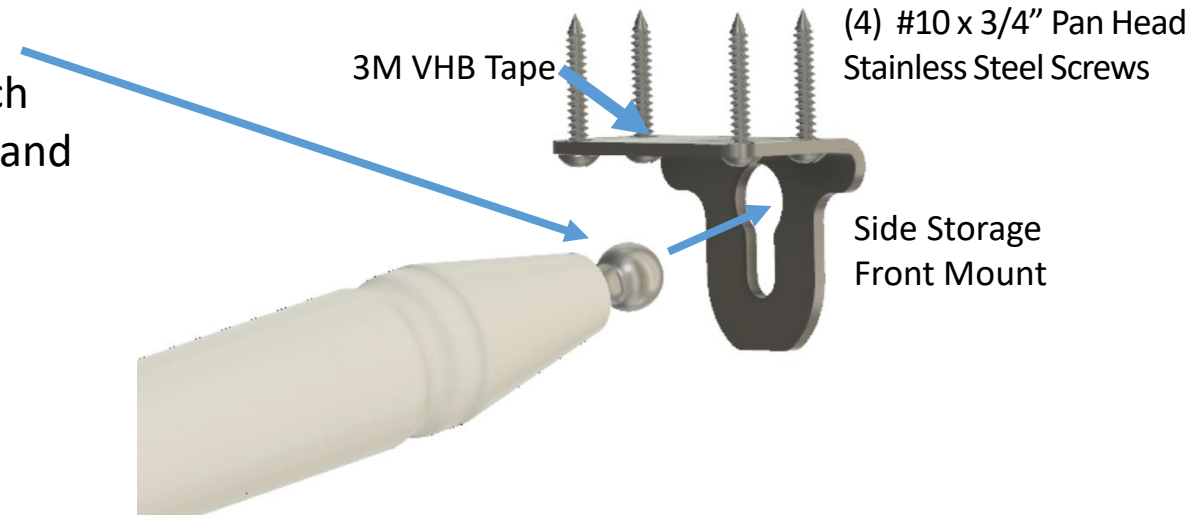

To remove the tube from the mount

1. Release the rear hanger mount and lower the end of the tube.



For Lance and Chalet Campers only

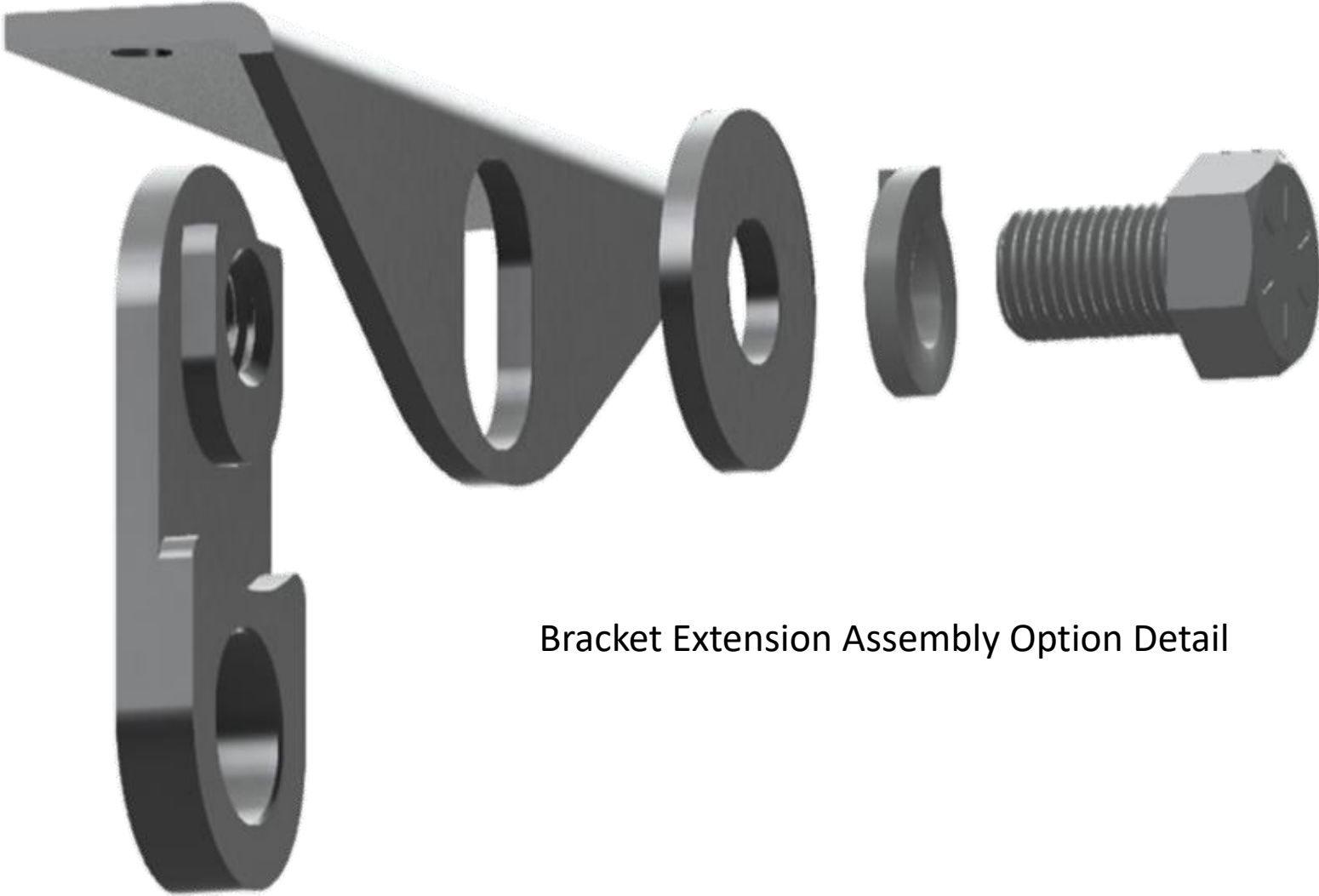

Bracket Extension Assembly Option Detail

Setup is easy:

Place the ball inside the socket on the jack clamp.

Insert the threaded end through the factory tie down bracket and secure with the knob.

Rotate the tube to hand tighten the assembly just enough to take the slack out of the system. Do not overtighten.

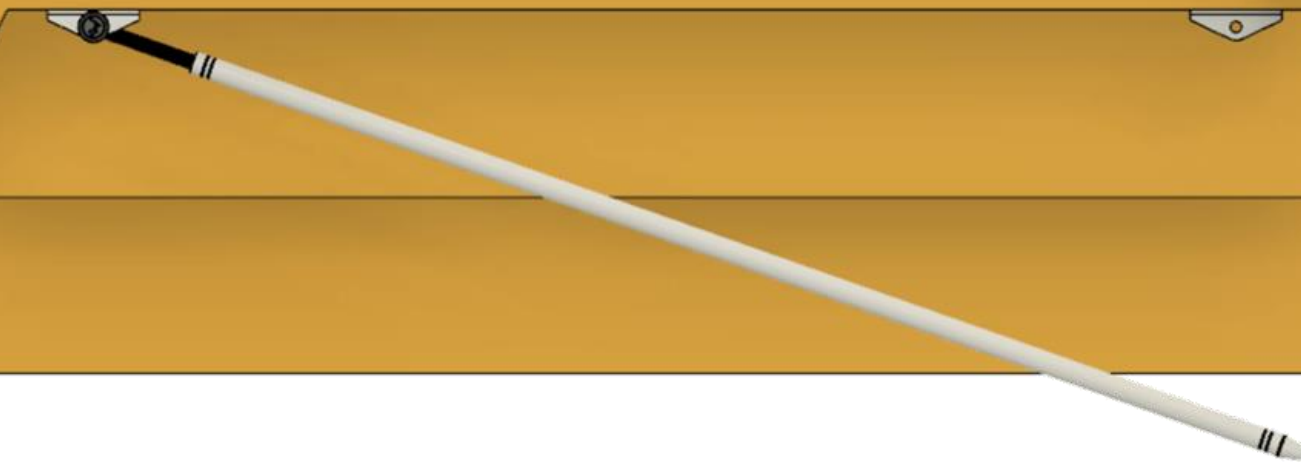
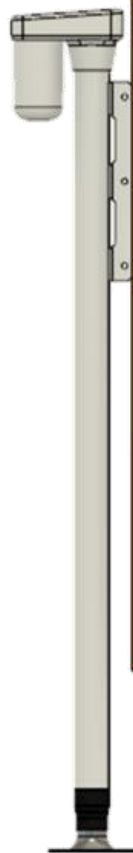

For the front tubes, rotate the tube from the storage position on the front storage hook and place the ball inside the socket on the jack clamp.
Rotate the tube to hand tighten the assembly just enough to take the slack out of the system.
Do not overtighten.

