

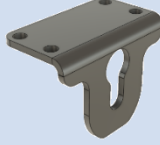

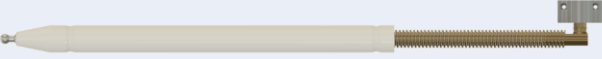

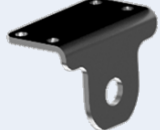



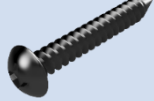

TM

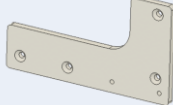
**STABLE  
CAMPER**



Parts List	# of Items		Parts List	# of items	
Jack Clamp	2		Side Storage Hanger Mount Front	2	
Front End Tube Assembly	2		Side Storage Hanger Mount Rear	2	
Truck Bed Side Tube Assembly	2		Hardware for Side Storage Hanger Mounts Front and Rear		#10 x 3/4" Stainless Steel Pan Head Screw (16) 
Front Storage Mount	1		Extended Front Mount Pre-2018 Models	1	
Hardware for Front Storage Mount		#10 x 1.5" Stainless Steel Flat Head Screw (4) 	Hardware for Extended Front Mount		#10 x 1.5" Stainless Steel Flat Head Screw (8) #10-24 x 5/8" Flat Head Screws (4)
Allen Wrench	1		Bumper Plate 2019 and Newer, campers with lower bumpers	2	
			Hardware for Bumper Plate		1 1/4" Lag Screw (4) #10 Flat Head Screws (4) 1/4-20 x 1 1/2" Phillips Pan Head Bolt (4)

## **General Notes:**

- **Before you begin the installation, remove the camper from the truck and make sure it is leveled.**
- **All mounted assemblies will need to be securely attached with supplied hardware to the camper frame.**
- **Avoid drilling pilot holes too close to the edge of the camper frame.**
- **Check the front tubes and hanger mounts as well as the side tubes and hanger mounts for any possible clearance issues.**
- **Confirm that the tubes will not be interfering with the tie down hooks, water, or any connections under the camper overhang.**
- **Apply RV sealant to all holes.**
- **Wear proper safety equipment.**
- **Do not stand, sit or climb on Stablecamper.**
- **The 3M VHB tape used on the front and rear side storage hanger mounts is very strong and repositioning the mounts after they have been fixed to the camper is not advised. When installing the mounts, be sure of placement before removing the adhesive backing and attaching the mounts with the supplied hardware.**

Mount the jack clamps to the fixed portion of the jack.

Drivers Side

Passenger Side

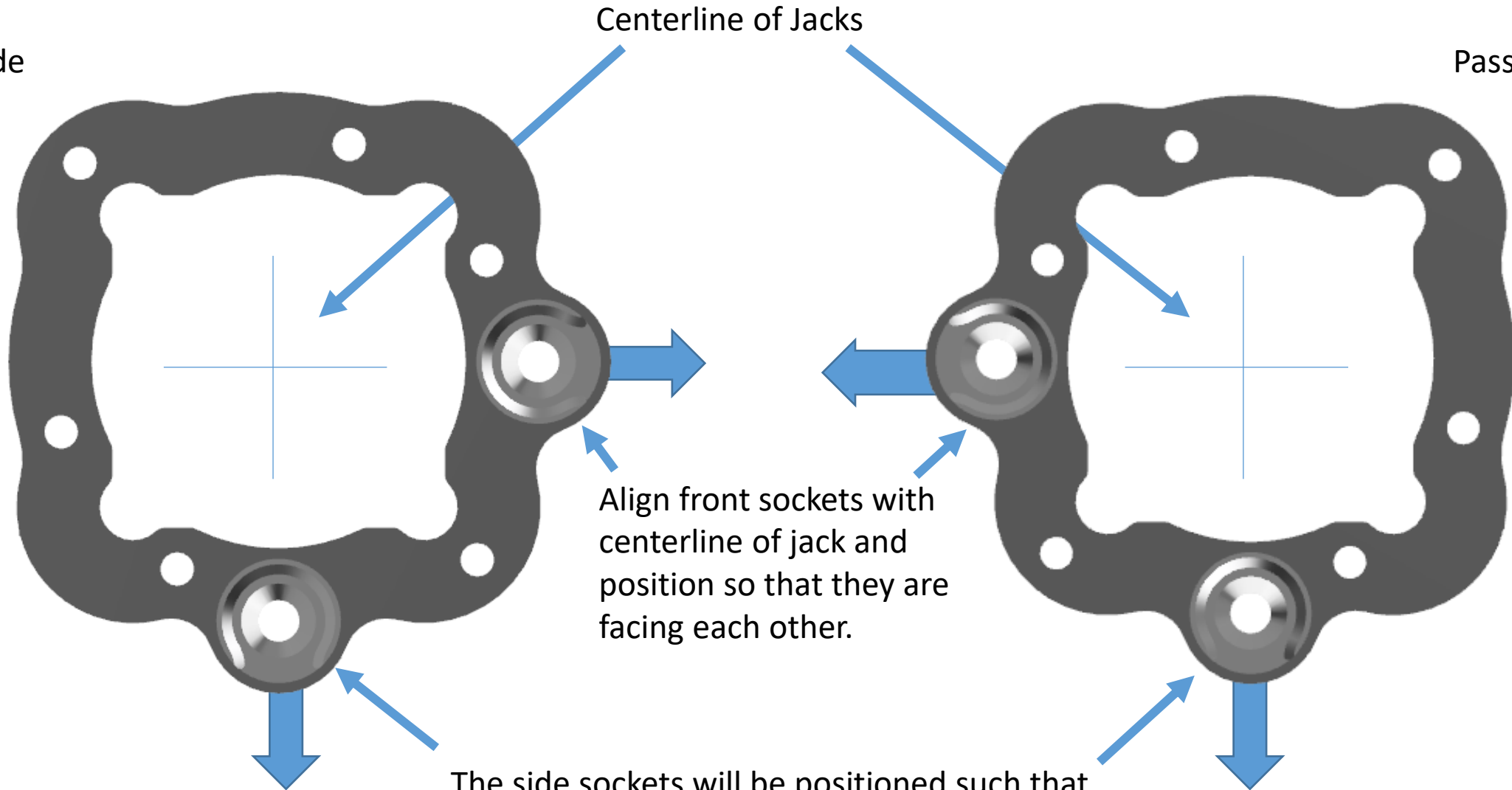

Centerline of Jacks

Align front sockets with centerline of jack and position so that they are facing each other.

The side sockets will be positioned such that they are collinear with the centerline of the jack as shown in the illustration.

# Jack Clamp Assembly Exploded View



## Vertical Placement of Jack Clamp

Vertical placement of jack clamp will vary depending on the maximum angle of the front tube.

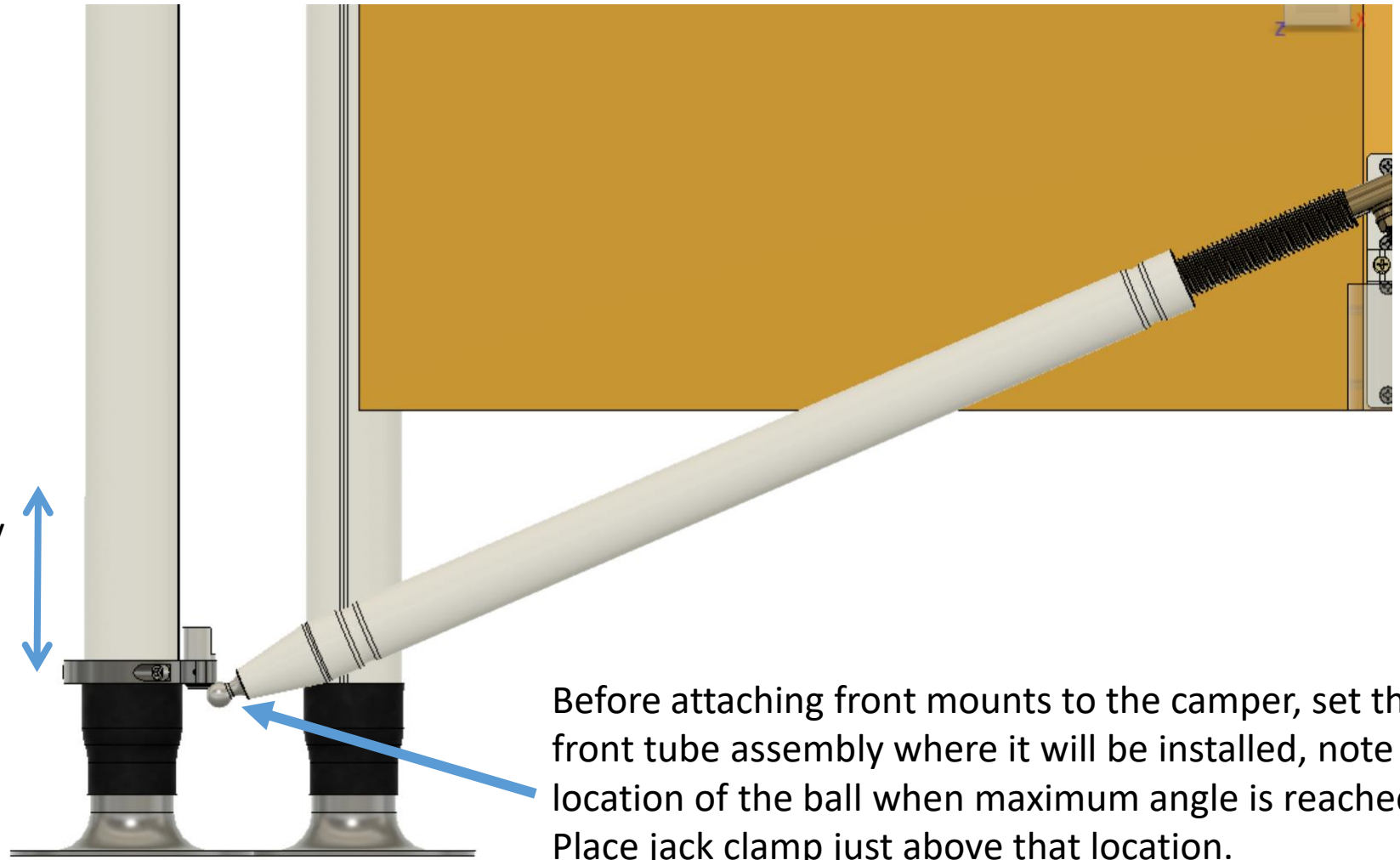

Before attaching front mounts to the camper, set the front tube assembly where it will be installed, note location of the ball when maximum angle is reached. Place jack clamp just above that location.

Passenger Side

View: Front Face of Camper

Driver Side

Please refer to the install page that is appropriate for your camper.  
Campers 2018 and older, with the bumpers located higher on the camper refer to page 8 for front mount install.  
Campers 2019 and newer, with bumpers located lower on the camper refer to pages 9-10 for bumper plate install.

Do not drill pilot holes too close to the edge of the camper frame. Use RV sealant on any holes and around the mounts. Mounted assemblies will need to be securely attached with supplied hardware to the camper frame.



## Extended Front Mount Detail For Campers 2018 and Older

There is a driver side and passenger side orientation to the front mounts. Position the front mounts so that they are mounting to the camper frame. Do not drill pilot holes too close to the edge of the camper frame. Use RV sealant on any holes and around the mounts.

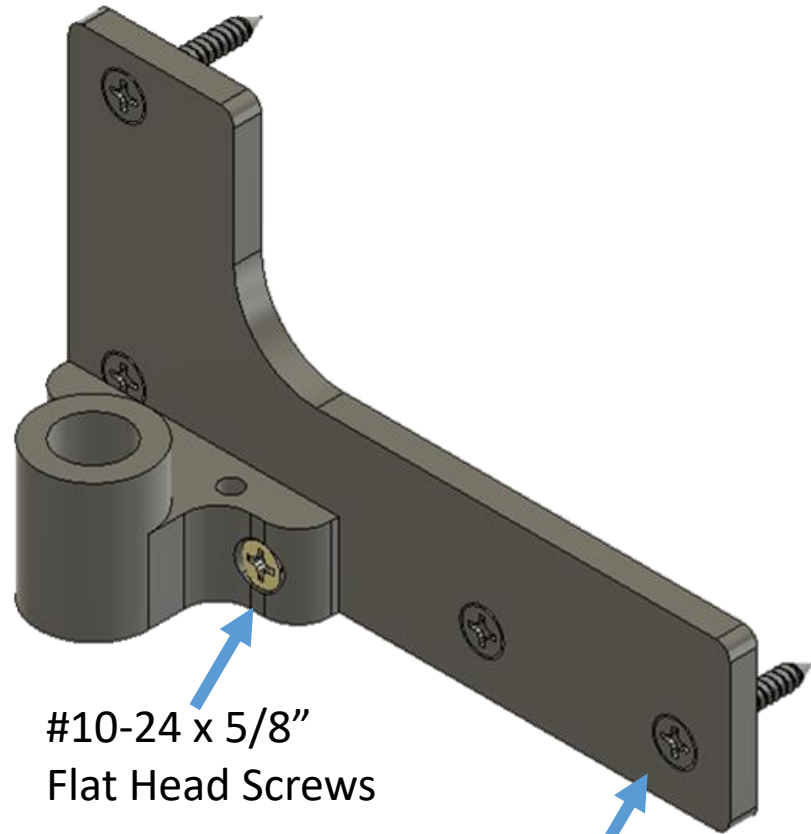

#10-24 x 5/8"  
Flat Head Screws

#10 x 1.5"  
Flat Head Screw

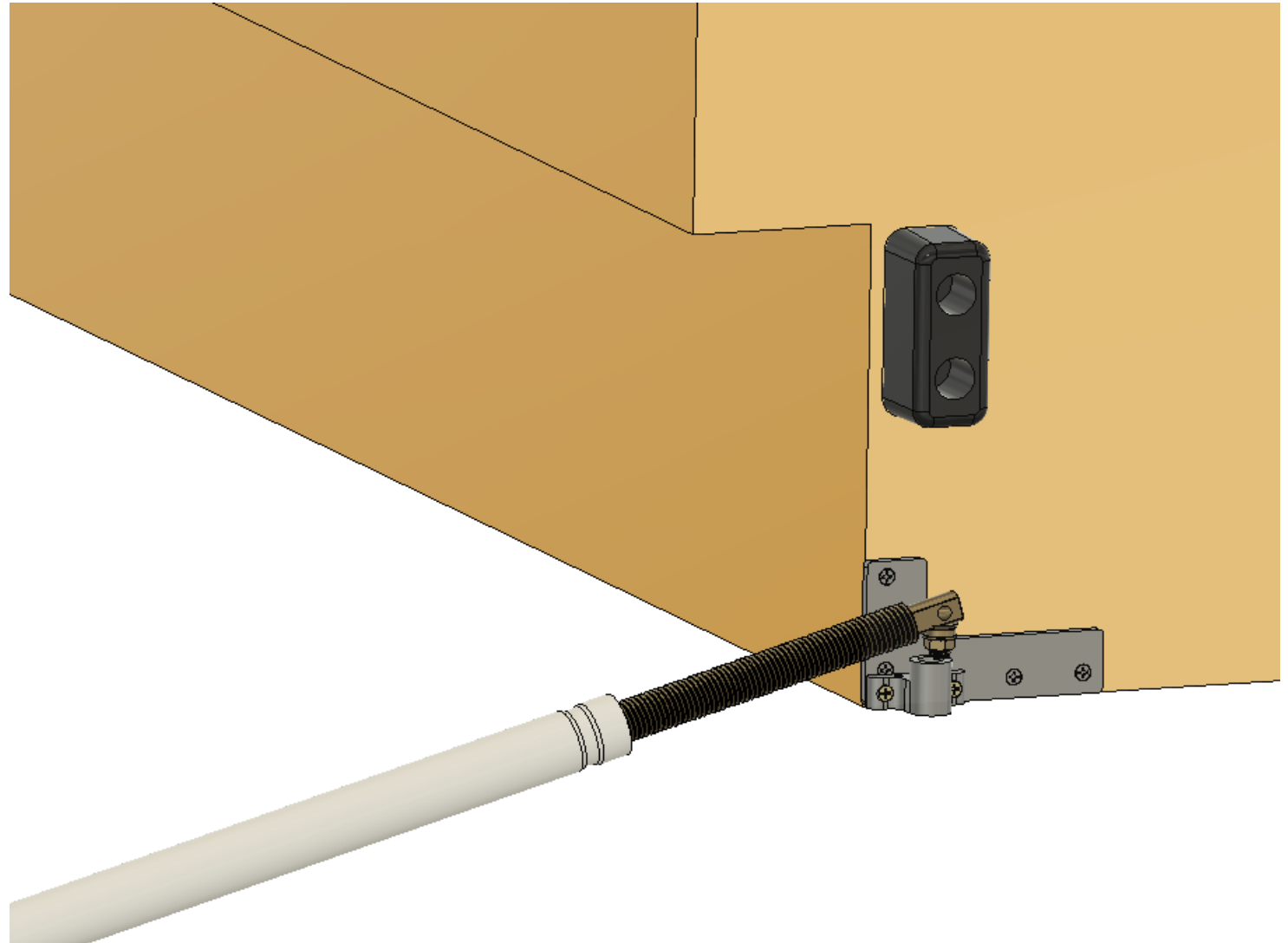



## Bumper Plate Install For Models 2019 and Newer

Remove Front Bumpers.  
Clear area of debris including  
old caulking/sealant.

Using Stablecamper supplied lag screws  
(1 ¼"), attach Stablecamper plates  
reusing the existing holes from the front  
bumpers. Caulk and seal as needed.

Attach Front Mounts with  
supplied #10 flathead  
screws. Don't forget to add  
the predrilling and sealant....

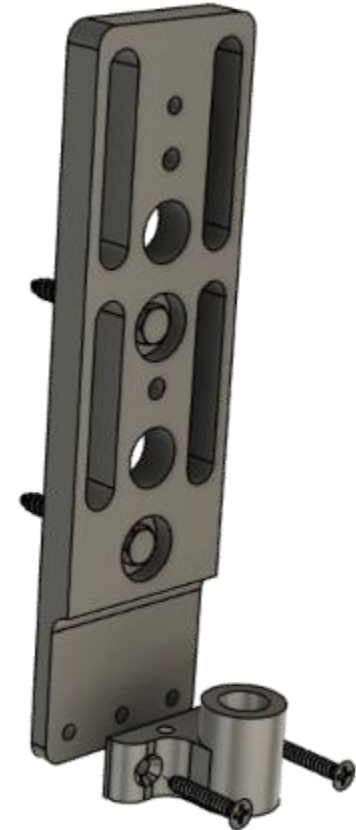
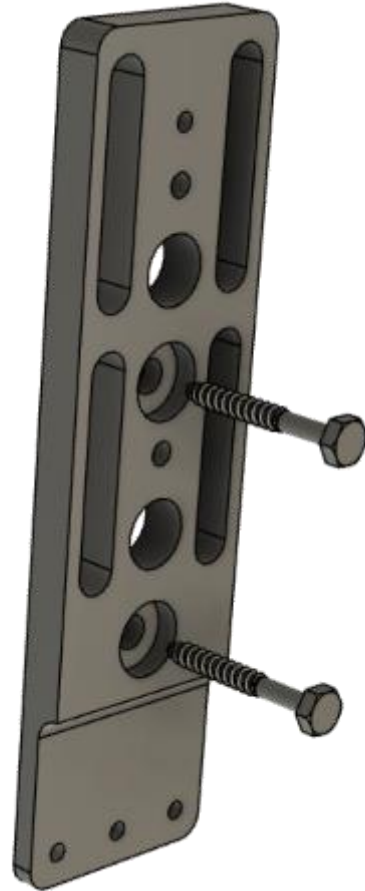
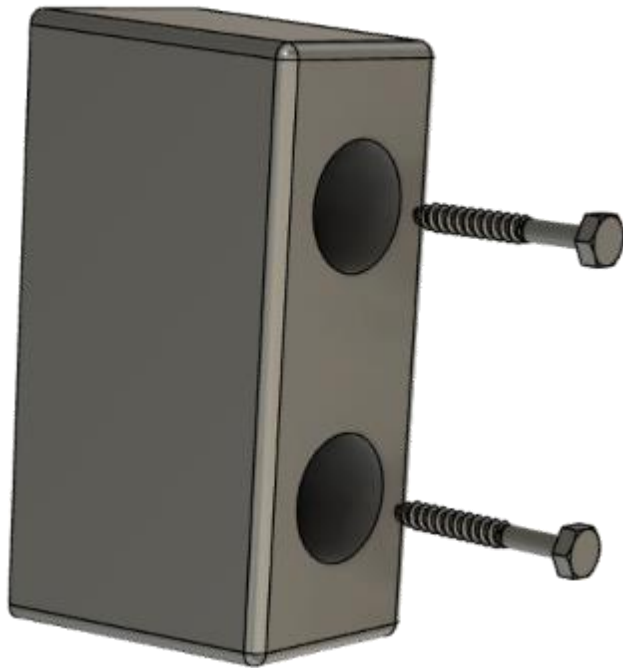

Thread front tube into secured front mount.



Attach bumpers with ¼-20 x 1 ½ supplied bolts to Stablecamper plates.

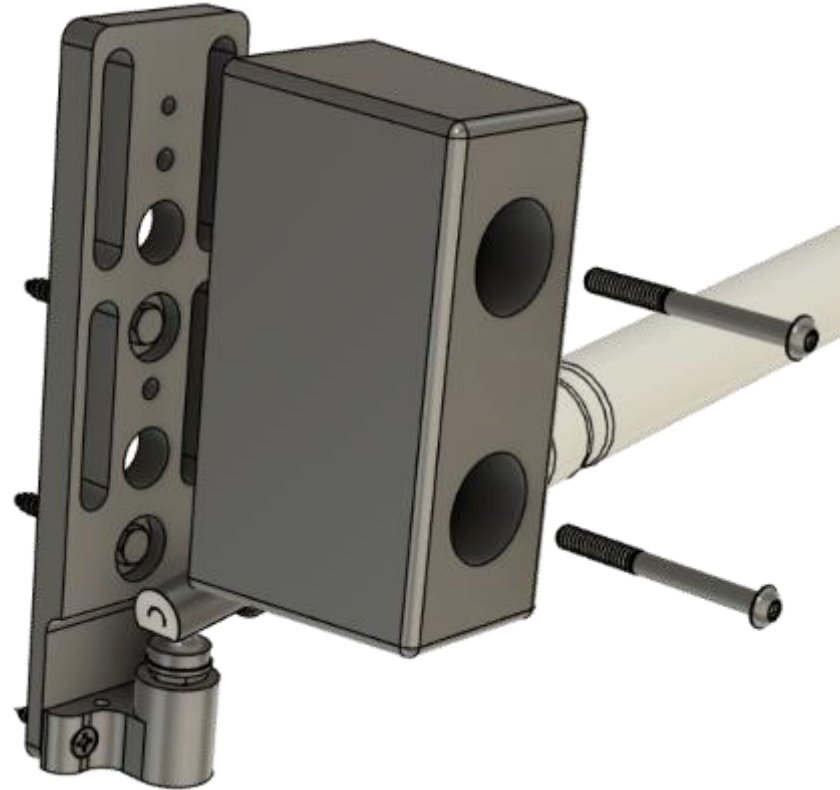

Passenger Side

View: Front Face of Camper

Driver Side

Position the front hanger bracket so that it is centered on the front face of the camper and attaching to the camper frame. Make sure it is positioned such that the front tubes rest on the tube rests. Drill (4) 9/64" pilot holes and attach with #10 x 1.5" flat head screws.

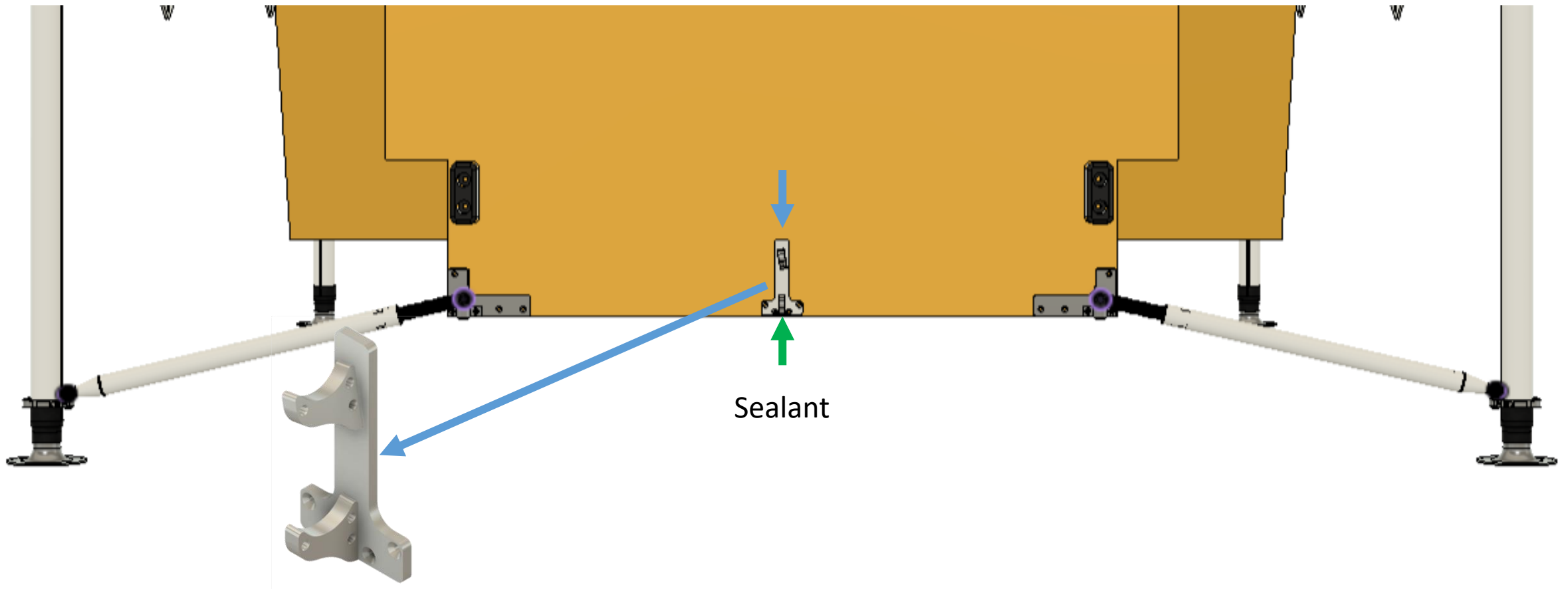

### View: Side Face of Camper

- Before installing the storage mounts for the side tubes on the underside of the camper, confirm that the distance between the hanger mounts is the same as the installed length of the Stablecamper before drilling pilot holes.

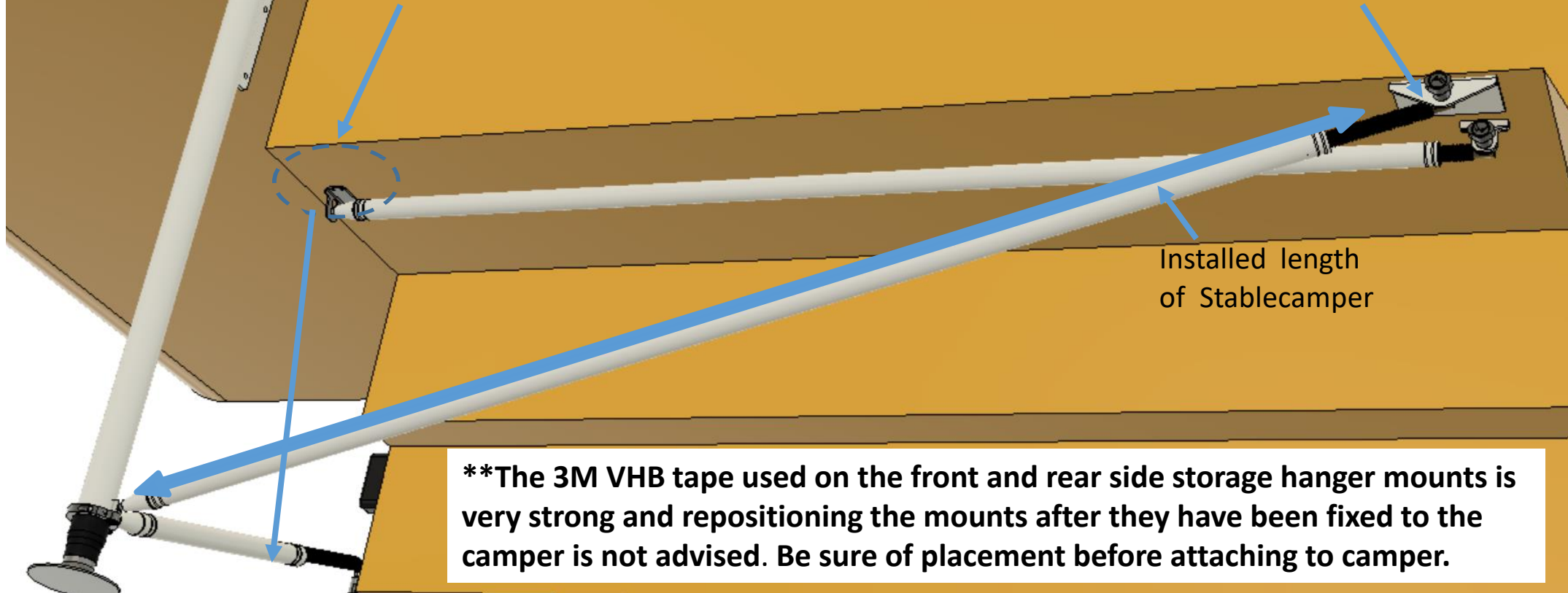

#### Zoomed in view of Front Hanging Mount

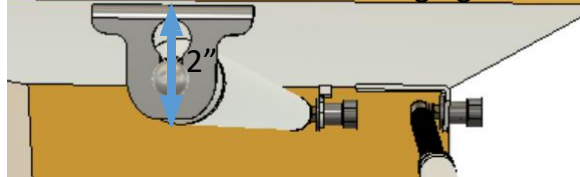

- Once stored on the hanging mounts, the tubes hang 2" below the underside of the camper. The exact placement of the hanging mounts will depend on the truck and your specific clearance needs. The mounts can be placed on the inside or the outside of the truck bedrail depending on your rig and setup.

## Side Storage Front Mount Detail

For side tube storage, insert the ball through the keyhole (resting against the neck of the ball). Attach the rear end of the tube to it's rear hanger mount and rotate the tube to tension the tube as desired.

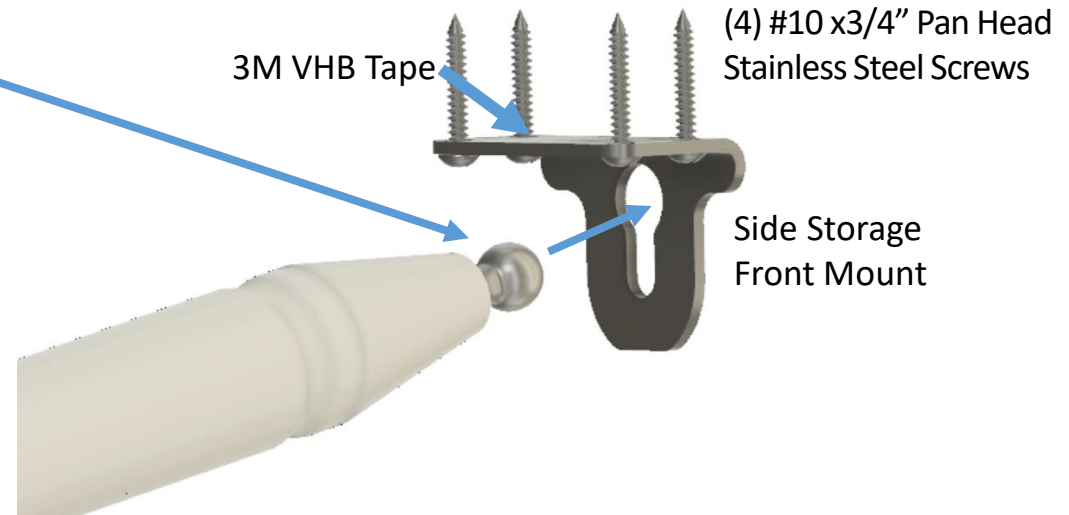

To remove the tube from the mount

1. Release the rear hanger mount and lower the end of the tube.



# Side Storage Hanger Mount Rear Detail

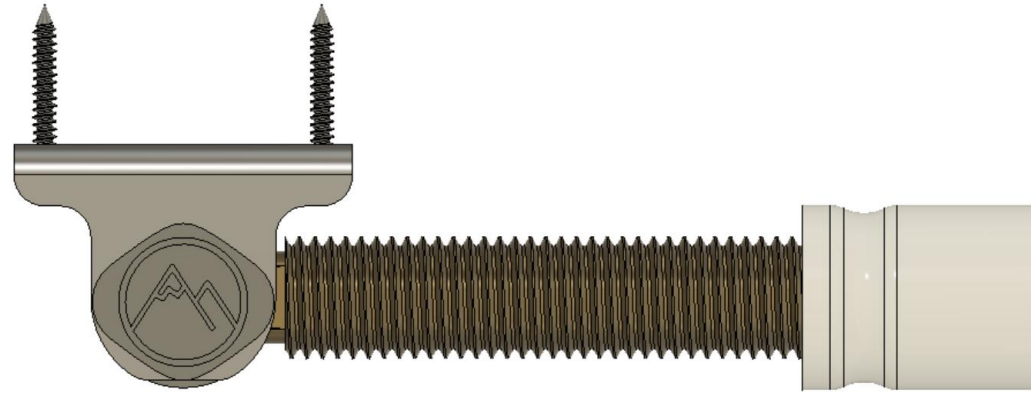
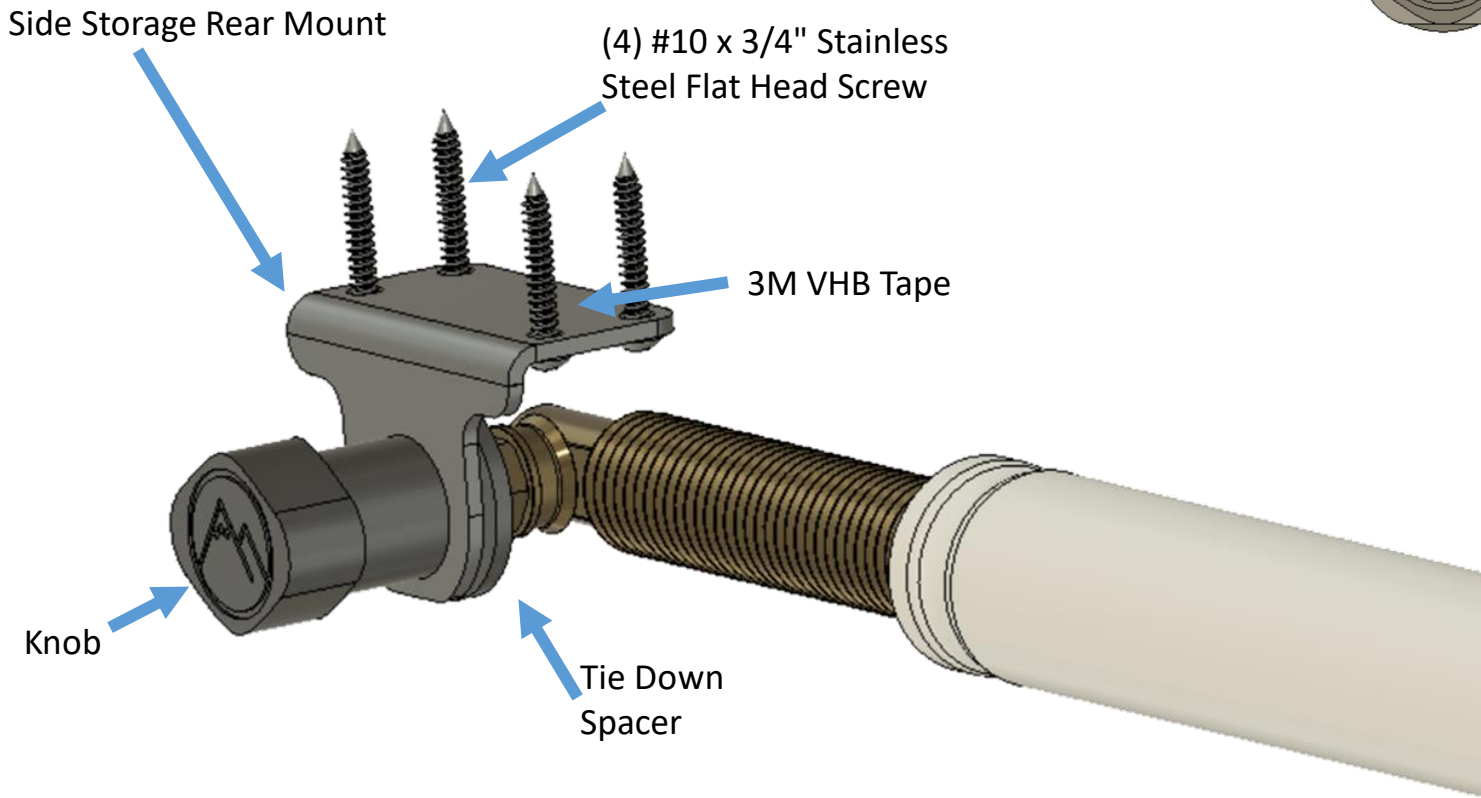

**\*\*Please note: The 3M VHB tape used on the front and rear side storage hanger mounts is very strong and repositioning the mounts after they have been fixed to the camper is not advised. When installing the mounts, be sure of placement before removing the adhesive backing and attaching the mounts with the screws.**

Setup is easy:

Place the ball inside the socket on the jack clamp.

Insert the threaded end through the factory tie down bracket and secure with the knob.

Rotate the tubes to hand tighten the assembly just enough to take the slack out of the system. Do not overtighten.

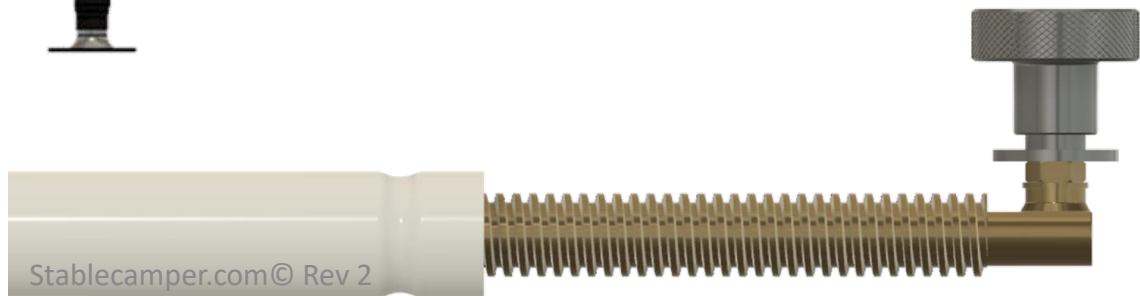
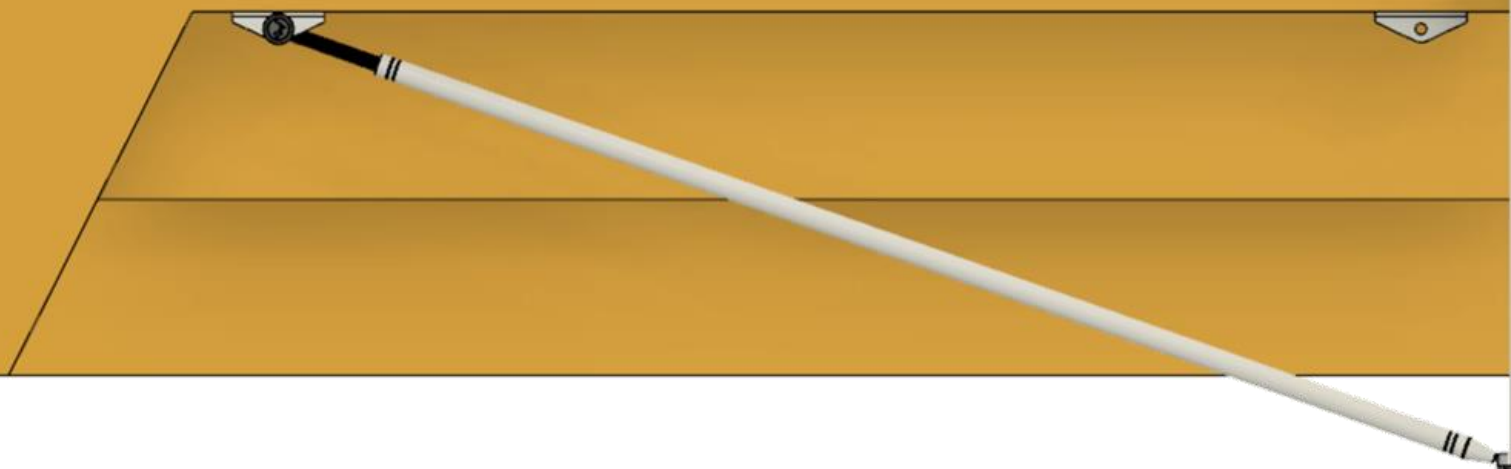
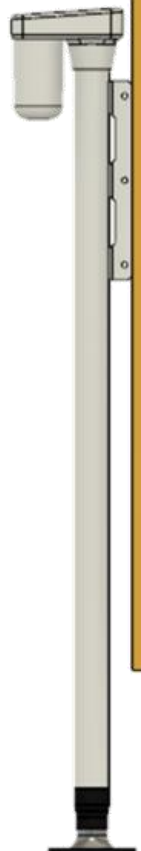

For the front tubes, rotate the tube from the storage position on the front storage hook and place the ball inside the socket on the jack clamp.  
Rotate the tubes to hand tighten the assembly just enough to take the slack out of the system.  
Do not overtighten.

